



State of California—Health and Human Services Agency
Department of Health Care Services



TOBY DOUGLAS
DIRECTOR

EDMUND G. BROWN JR.
GOVERNOR

DATE: AUGUST 9, 2012

MMCD POLICY LETTER 12-006
SUPERSEDES POLICY LETTER 11-013

TO: ALL MEDI-CAL MANAGED CARE HEALTH PLANS

SUBJECT: REVISED FACILITY SITE REVIEW TOOL

PURPOSE:

The purpose of this Policy Letter (PL) is to establish Medi-Cal managed care health plan (Plan) requirements for the implementation of the attached Facility Site Review (FSR) Tool Attachment C. The Department of Health Care Services (DHCS) developed the requirements for FSR Attachment C pursuant to Welfare and Institutions (W&I) Code Section 14182(b)(9). The existing site review process, or FSR Tool, detailed in the Medi-Cal Managed Care Division's (MMCD) PL 02-02, remains in effect and will now incorporate these new requirements for assessing the level of physical accessibility of provider sites, including specialist and ancillary service providers, that serve a high volume of Seniors and Persons with Disabilities (SPDs).

BACKGROUND:

A key element of California's "Bridge to Reform" 1115 Medicaid Demonstration Waiver, approved by the Centers for Medicare and Medicaid Services on November 2, 2010, is to provide SPD beneficiaries with access to organized and coordinated care. This includes the transition of SPDs into Plans, which commenced on June 1, 2011.

Per PL 02-02, Health and Safety Code Section 1342.8 requires the streamlining of regulatory processes and a reduction in redundant reviews of physician offices by coordinating, to the extent feasible, as many of those regulatory functions as possible. In each county, Plans shall determine the collaborative processes, systems, and methods that will be used locally to coordinate review processes and decrease redundant site visits. Site review responsibilities may be shared equally by all Plans within a county, delegated to one or more Plans, and/or subcontracted to other agencies/entities. All Plans are responsible for the coordination and consolidation of provider site reviews and therefore share responsibility for defining the local process.

It is not required that FSR Tool Attachment C be conducted by a registered nurse or physician. As with the existing attachments of the FSR Tool, Plans may delegate site review responsibilities to another DHCS contracted Plan or subcontract responsibilities to an appropriate agency/entity. However, the delegating Plan remains responsible to ensure surveys completed by delegated entities are conducted in compliance with the site review requirements.

In order to determine which specialists and ancillary providers serve a high volume of SPDs, Plans were required by January 31, 2011, to submit to the DHCS initial documentation of the following:

1. Benchmarks established by Plans to determine what constitutes high volume for each category of specialty and ancillary service providers included in their provider directories;
2. The methodology Plans used to develop their benchmarks;
3. A summary of the utilization or other data used to support the methodology;
4. Any categories of specialty and ancillary service providers that do not have enough utilization to qualify for high volume usage; and
5. A listing of the specific high volume specialty and ancillary service providers for whom Plans will administer FSR Attachment C within the next 12 to 36 months.

REQUIREMENTS:

All Two-Plan Model and Geographic Managed Care (GMC) Plans are already meeting the requirements of this PL. Any changes to currently approved submissions must adhere to the revised requirements below.

County Organized Health System (COHS) Plans must submit documentation to their MMCD contract manager according to the below requirements within 30 days of the date on this letter. DHCS will review and respond to these submissions within 30 days of receipt. If the documentation is not approved, DHCS will contact the Plans immediately and work quickly to resolve any issues. Once approved, COHS Plans must begin using Attachment C according to the requirements of this PL by November 2, 2012.

Documentation for the implementation of FSR Attachment C must include the following:

1. One of the following benchmarks must be selected and defined to determine what constitutes high volume for each category of specialty and ancillary service providers included in the Plan's provider directory:
 - Establish an average of a specified number of visits made per month by unique SPD members, or a specified number of visits per 12-month period made by unique SPD members to a specialty or ancillary service provider, group, or site.
 - Establish a "frequency of use" benchmark based on more-or-less than a specified number of visits per day and the number of lines of claims or services provided during the specified number of visits.
 - Establish a benchmark based on the percentage of the Plan's SPD members who have been seen by a specialist within a 12-month timeframe or ancillary providers that have had more than a specified number of encounters with the Plan's SPD members during a 12-month timeframe.
 - Establish a benchmark based on the number of specialty or ancillary providers with a specified volume of claim lines during a 12-month period and add additional providers to this list if they appear to be significant providers of services to SPDs even though their number of claim lines was lower than the benchmark.
 - Determine the highest-to-lowest number of claims over a 12-month period for all specialty and ancillary providers, develop an average number of claims for each specialty or ancillary provider type, and determine that any specialty or ancillary provider with claims greater than the average would be considered high volume.
 - Decide to use FSR Attachment C on all specialty and ancillary sites, not differentiating between low and high volume providers. If this approach is used, then no other documentation is needed for approval.
2. The methodology Plans used to develop their benchmarks.
3. A summary of the utilization or other data used to support the methodology.
4. Any categories of specialty and ancillary service providers that do not have enough utilization to qualify for high volume usage.

5. A comprehensive list of providers that will be assessed by the Plans using FSR Attachment C during the next 12 to 36 months. This list must include high volume specialty and ancillary service providers.

All documentation must be submitted to the MMCD contract managers. For yearly submissions, if no changes have been made, a letter stating this must be submitted to the contract managers. If there are changes, all documentation must be submitted in red-line to clearly identify the changes.

Plan contracts will be amended to include the new requirements relating to the use of the enclosed FSR Attachment C pursuant to W&I Code Section 14182(b)(9).

Plans are required to use FSR Attachment C to assess the physical accessibility of provider sites, including specialist and ancillary service providers that serve a high volume of SPDs. DHCS recognizes that hospitals represent a unique group of ancillary providers; therefore, Plans are required to collaborate with the hospitals in their network to assess whether they meet all of the elements in Attachment C and make this information available through both the Plan's website and their provider directories. Plans must demonstrate that they have received adequate documentation from the hospitals to complete Attachment C and maintain the records that support their assessment of each hospital in their network.

Plans are to make the results of FSR Attachment C available to members through their websites and provider directories. The information provided must, at a minimum, display the level of access results met per provider site as either Basic Access or Limited Access. Additionally, Plans must indicate whether the site has Medical Equipment Access as defined in FSR Attachment C, and identify whether each provider site has or does not have access in the following categories: parking, building exterior, building interior, exam room, restroom, and medical equipment (height adjustable exam table and patient accessible weight scales).

Plans will be required to submit updated documentation of the above by January 31st of each year indicating any changes made to the high volume benchmarks as a result of the availability of more complete utilization data. DHCS will continue to review these annual submissions and provide feedback to Plans regarding any areas of concern.

The results of FSR Attachment C are informational and unlike FSR Attachments A (Site Review Survey) and B (Medical Records Review Survey) do not require corrective action. However, Plans are required to maintain all original documentation of their FSR

assessments and make this information available to DHCS or its representative for contract monitoring or auditing purposes.

IMPLEMENTATION TIMELINE:

Per previous PL 11-013, effective May 23, 2011, Plans are required to begin using FSR Attachment C in line with the current three year cycle requirement of FSR Attachments A and B. Once the Plans have submitted the proper documentation for the benchmarks as detailed on page 3 of this PL, and they have received approval from DHCS, they may begin utilizing FSR Attachment C to assess the level of physical accessibility of provider sites that serve a high volume of SPDs. New providers that meet the criteria mentioned above are subject to FSR Attachment C review immediately.

If you have any questions regarding this PL, please contact your MMCD contract manager.

Sincerely,

ORIGINAL SIGNED BY MARGARET TATAR

Margaret Tatar, Chief
Medi-Cal Managed Care Division

Attachment: FSR Attachment C-Physical Accessibility Review Survey

Physical Accessibility Review Survey

California Department of Health Care Services
Medi-Cal Managed Care Division

Provider Name: <input type="checkbox"/> PCP <input type="checkbox"/> Specialist <input type="checkbox"/> Ancillary	Date of Review:
	Name of Reviewer:
Address:	Health Plan Name:
City:	
Phone: FAX:	Contact Person Name:
	<i>Level of Access:</i>
<u>Basic Access:</u> Demonstrates facility site access for the members with disabilities to parking, building, elevator, doctor's office, exam room and restroom. To meet Basic Access requirements, all (29) Critical Elements (CE) must be met.	<input type="checkbox"/> Basic Access
<u>Limited Access:</u> Demonstrates facility site access for the members with a disability is missing or is incomplete in one or more features for parking, building, elevator, doctor's office, exam room, and restroom. Deficiencies in 1 or more of the Critical Elements (CE) are encountered.	<input type="checkbox"/> Limited Access
<u>Medical Equipment Access:</u> PCP site has height adjustable exam table and patient accessible weight scales per guidelines (for wheelchair/scooter plus patient). This is noted in addition to level of Basic or Limited Access as appropriate.	<input type="checkbox"/> Medical Equipment is available

Below are the symbols that will be used in the provider directories to indicate areas of accessibility at a provider office/site. These should also be used in online directories. In order for a provider office to receive a symbol, the appropriate criteria must be met.

These symbols are in addition to identifying whether the provider office has Basic Access or Limited Access. A provider who has Basic Access will automatically meet the critical elements for the first six symbols (P, EB, IB, R, and E). And a provider who has Medical Equipment Access will meet the medical equipment elements for the last symbol (T).

Accessibility Indicator	Must Satisfy these Criteria	Yes	No	N/A	Comments
P = PARKING	Critical Elements (CE): 3, 7, 8, 11				
EB - EXTERIOR BUILDING	(CE): 14, 20, 22, 23 25, 27, 28, 31				
IB = INTERIOR BUILDING	(CE): 31, 34, 37 If lift include: 40 If elevators include: 53, 54, 55, 56, 57, 58				
R=RESTROOM	(CE): 65, 67, 68, 71, 75, 77				
E=EXAM ROOM	(CE): 80, 85				
T = EXAM TABLE/SCALE	Medical Equipment Elements (ME): 81, 82, 86				

I certify that there have been no changes since the last physical accessibility review:

Name: _____ Signature: _____ Date: _____

I certify that there have been no changes since the last physical accessibility review:

Name: _____ Signature: _____ Date: _____

Question #	Criteria (CE = Critical Elements)	Explanation/Guidelines	Yes	No	N/A	Comments
------------	--------------------------------------	------------------------	-----	----	-----	----------

PARKING

1	Is off-street public parking available?	Self explanatory.				
2	Are accessible parking spaces provided in off-street parking?	Self explanatory.				
3 (CE)	Are the correct number of accessible parking spaces provided? 1 to 25 total spaces - 1 required 26 to 50 - 2 required 51 to 75 - 3 required 76 to 100 - 4 required 101 to 150 - 5 required 151 to 200 - 6 required 201 to 300 - 7 required 301 to 400 - 8 required	If there are 25 total parking spaces or less, at least one accessible space is required. If there are between 26 and 50 total spaces, at least two accessible spaces are required, etc.				

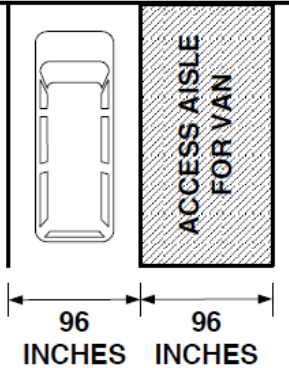
Question #	Criteria (CE = Critical Elements)	Explanation/Guidelines	Yes	No	N/A	Comments
4	Is the accessible parking space(s) closest to the main entrance?	The accessible parking space (s) should afford the shortest route of travel from adjacent parking to the accessible entrance.				
5	Is there an access aisle next to the accessible space(s)?	<p>The access aisle is the space next to the accessible parking space where a person using the accessible space can load and unload from the vehicle.</p>  <p style="text-align: center;"> 96 INCHES 96 INCHES </p>				
6	Is the parking space(s) and access aisle(s) free of curb ramps that extend into the space and other obstructions?	If a curb ramp extends into the parking space(s) or access aisle, a person using that space and aisle would not have adequate level space to unload and load from the vehicle.				

Question #	Criteria (CE = Critical Elements)	Explanation/Guidelines	Yes	No	N/A	Comments
7 (CE)	Do curbs on the route from off-street public parking have curb ramps at the parking locations?	Pathways should have curb ramps. Without curb ramps, wheelchair users may be required to travel in the street or behind parked cars where drivers cannot see them.				
8 (CE)	Do curbs on the route from off-street public parking have curb ramps at the drop off locations?	See above Question # 7.				
9	Does every accessible parking space have a vertical sign posted with the International Symbol of Accessibility?	<p>Symbol in the illustration depicts the International Symbol of Accessibility.</p>  <p>6</p>				

Question #	Criteria (CE = Critical Elements)	Explanation/Guidelines	Yes	No	N/A	Comments
10	Are signs mounted a minimum of 60 inches above the ground surface so that they can be seen over a parked vehicle?	Signs must be located so a vehicle parked in the space does not obscure them. (Van accessible spaces must be indicated with an additional sign)				
11 (CE)	Is VAN accessible parking provided?	1 van space for every 6 standard accessible spaces must be provided, but never less than one. For example, if there are 23 total spaces, at least one accessible space is required and it must be large enough (See Question # 5 for dimensions) to accommodate a van. If there are 201 total parking spaces, at least seven accessible spaces would be required and two of those would have to accommodate vans.				
12	Is VAN accessible parking signage provided?	Signs must be mounted a minimum of 60 inches above the ground surface so that they can be seen over a parked vehicle.				

Question #	Criteria (CE = Critical Elements)	Explanation/Guidelines	Yes	No	N/A	Comments
------------	-----------------------------------	------------------------	-----	----	-----	----------

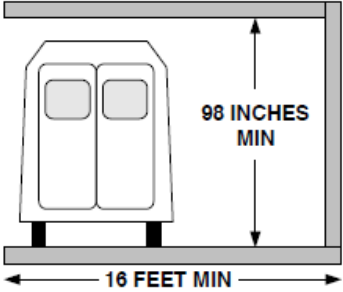
13	<p>If van accessible parking is provided in a parking garage, is there at least 8 feet 2 inches (98 inches total) vertical clearance available for full-sized, lift equipped vans?</p>	<p>If there is no parking garage, check NA.</p> <p>If designated accessible parking is located in a garage, the vertical clearance should be at a minimum 8 feet 2 inches (98 inches). Vertical clearance should be posted.</p> 				
----	--	--	--	--	--	--

EXTERIOR ROUTE (FROM ACCESSIBLE PARKING, PUBLIC TRANSPORTATION, AND PUBLIC SIDEWALK TO THE ENTRANCE)

14 (CE)	<p>For exterior routes, if the accessible route crosses a curb, is a curb ramp provided to the building entrance from the following: (Please mark NA for those that do not apply.)</p>	<p>Self explanatory.</p>				
	a. Parking?					
	b. Public transportation?					

Question #	Criteria (CE = Critical Elements)	Explanation/Guidelines	Yes	No	N/A	Comments
------------	-----------------------------------	------------------------	-----	----	-----	----------

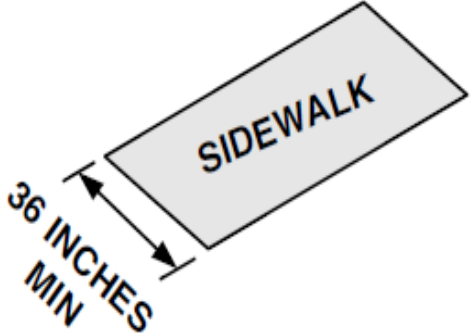
	c. Public sidewalk?					
15	Is the accessible route to the building entrance at least 36 inches wide for exterior routes from the following: (Please mark NA for those that do not apply.)	 <p>The diagram shows a rectangular area labeled 'SIDEWALK' tilted at an angle. A double-headed arrow indicates the width of the sidewalk, with the text '36 INCHES MIN' written below it.</p>				
	a. Parking?					
	b. Public transportation?					
	c. Public sidewalk?					
16	Is the accessible route to the building entrance stable, firm, and slip resistant from the following: (Please mark NA for those that do not apply.)	<p>An example of a stable surface is a floor or ground surface without loose elements like gravel or wood chips.</p> <p>Firm surfaces include solid concrete or pavement as opposed to a grassy, graveled or soft soil surface.</p> <p>Avoid glossy or slick surfaces such as ceramic tile.</p>				
	a. Parking?					

Question #	Criteria (CE = Critical Elements)	Explanation/Guidelines	Yes	No	N/A	Comments
	b. Public transportation?					
	c. Public sidewalk?					
17	Is there an accessible route that does not include stairs or steps?	Self explanatory.				
18	Is the route to the entrance from the accessible parking spaces, including transitions at curb ramps, free of grates, gaps, and openings that are both greater than ½ inch wide and over ¼ inch deep?	Self explanatory.				
RAMPS:						
19	Is an access ramp present?	If there is more than one ramp, select the one that appears to be the primary access ramp.				

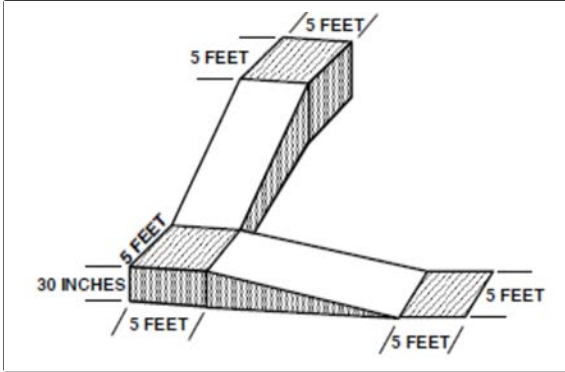
Question #	Criteria (CE = Critical Elements)	Explanation/Guidelines	Yes	No	N/A	Comments
20 (CE)	Is each run (leg) of the ramp no longer than 30 feet between landings?	<p>Each "run," shown in the white sections in the diagram below, must be no longer than 30 feet.</p> 				
21	Are 60 inches (5 feet) long, level landings provided at the top and bottom of each ramp run?	See Question 20 diagram above.				

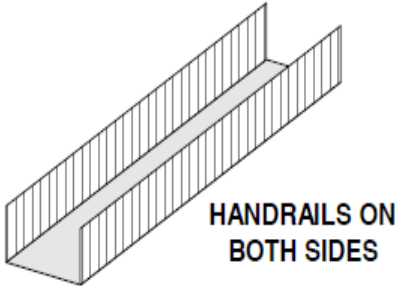
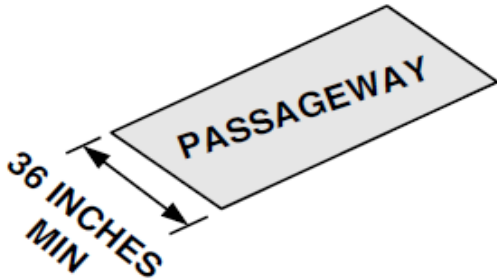
Question #	Criteria (CE = Critical Elements)	Explanation/Guidelines	Yes	No	N/A	Comments
22 (CE)	Are handrails provided on both sides of the ramp that are mounted between 34 and 38 inches above the ramp surface, if it is longer than 6 feet?	<p>If the ramp is not longer than 6 feet, check NA.</p> 				
23 (CE)	Are all ramps at least 36 inches wide?					

Question #	Criteria (CE = Critical Elements)	Explanation/Guidelines	Yes	No	N/A	Comments
------------	-----------------------------------	------------------------	-----	----	-----	----------

BUILDING ENTRANCE

24	Is the main entrance accessible?	Self explanatory.				
25 (CE)	If a main entrance is not accessible, is there another accessible entrance?	Self explanatory.				
26	If a main entrance is not accessible, is there directional signage indicating the location of the accessible entrance?					

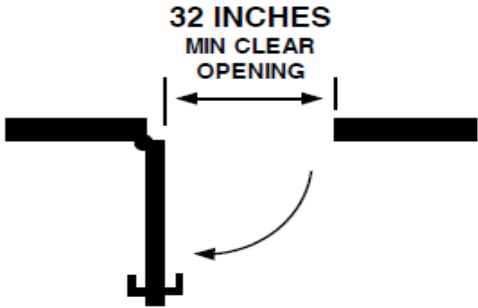
Question #	Criteria (CE = Critical Elements)	Explanation/Guidelines	Yes	No	N/A	Comments
27 (CE)	Do doors have an opening at least 32 inches wide (at the narrowest point below the opening hardware) when opened to 90°?	<p>When measuring double doors, measure the opening with one door open to 90°.</p> 				
28 (CE)	Is space available for a wheelchair user to approach, maneuver, and open the door?	<p>Appropriate space perpendicular and parallel to a doorway permits a wheelchair user, people using walkers and other mobility devices to open the door safely and independently. Following are two common examples of required minimum maneuvering clearances:</p> <ol style="list-style-type: none"> 1. Approaching the door and pulling it toward you to open requires 60 inches of clear space perpendicular to the doorway and 18 inches parallel to the doorway. 2. Approaching the door and pushing it away from you to open requires 48 inches of clear space perpendicular to the doorway. 				

Question #	Criteria (CE = Critical Elements)	Explanation/Guidelines	Yes	No	N/A	Comments
------------	-----------------------------------	------------------------	-----	----	-----	----------

		<p>(a) front approach, pull side</p> <p>(c) front approach, push side, door provided with both closer and latch</p>				
--	--	---	--	--	--	--

29	Is the space required to open the door level and clear of movable objects (chairs, trash cans, etc.)?	If there are nonpermanent items such as trash cans, merchandise, etc., located in these areas, they must be removed or relocated.				
----	---	---	--	--	--	--

Question #	Criteria (CE = Critical Elements)	Explanation/Guidelines	Yes	No	N/A	Comments
30	Are there automatic doors?	Self explanatory.				
31 (CE)	Do entrance doors have handles that can be opened without grasping, pinching, or twisting of the wrist?	Can the door be opened by someone with a closed fist or fully open hand? Door knobs, for example, cannot be used in this manner.				
INTERIOR ROUTE (FROM THE BUILDING ENTRANCE TO THE CLINIC/OFFICE ENTRANCE, TO THE REGISTRATION COUNTER/WINDOW, AND THROUGH THE CLINIC/OFFICE TO AREAS THAT PATIENTS COULD GO)						
32	Is there an interior route to the medical office?	Some medical offices are accessed directly from the street or parking lot rather than being located within a larger office building or complex, therefore they do not have interior routes.				

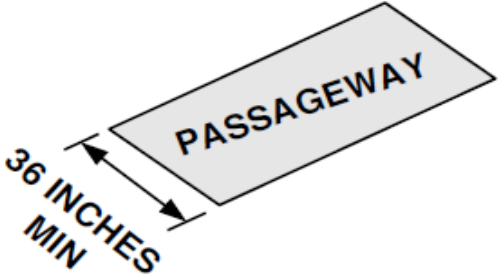
Question #	Criteria (CE = Critical Elements)	Explanation/Guidelines	Yes	No	N/A	Comments
33	Is there an interior accessible route to the medical office that does not include stairs or steps?	Floors of a given story are level throughout the building, or connected by ramps, passenger elevators or access lifts.				
34 (CE)	Are <u>ALL</u> interior paths of travel at least 36 inches wide?					
35	Is the interior accessible route stable, firm, and slip resistant?	<p>Avoid unsecured carpeting or other loose elements.</p> <p>It is easier for people using walkers, wheelchairs and other aids to walk or push on surfaces that have low pile carpeting without a pad underneath.</p> <p>Glossy or slick surfaces such as ceramic tile or marble can be slippery.</p>				
36	Is the interior accessible route well lighted?	A brightly lit corridor will help avoid falls.				

Question #	Criteria (CE = Critical Elements)	Explanation/Guidelines	Yes	No	N/A	Comments
37 (CE)	If there are stairs on the accessible route, are there handrails on each side?	If there are no stairs, check NA.				
38	If there are stairs, are all stairs risers closed that are on the accessible route?					
39	If there are stairs, are all stair treads marked by a stripe providing a clear visual contrast to assist people with visual impairments?	Contrast striping must be provided on the upper approach and lower tread for interior stairs and on the upper approach and all treads for exterior stairs. Stripes must be 2" to 4" wide placed parallel to and no more than 1" from the nose of the step or upper approach. The stripe must extend the full width of the step or upper approach and should be made of material that is at least as slip resistant as the other stair treads (a painted stripe is acceptable).				
40 (CE)	If a platform lift is used, can it be used without assistance?	If there is no platform lift, check NA. Lifts sometimes require a key for operation, thus preventing independent use.				

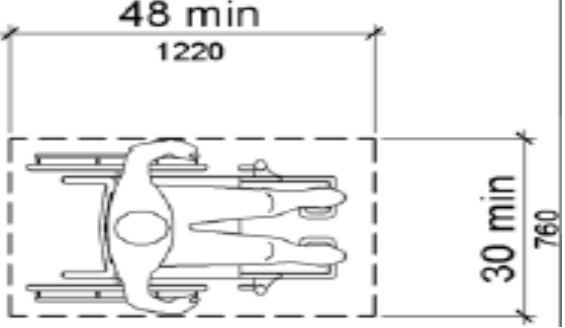
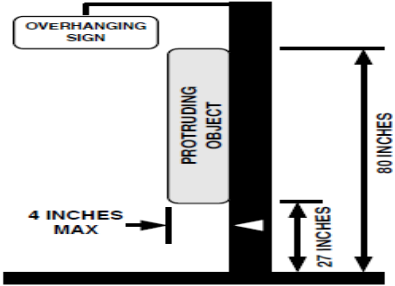
Question #	Criteria (CE = Critical Elements)	Explanation/Guidelines	Yes	No	N/A	Comments
41	Does the interior door to the medical office require less than 5 pounds of pressure to open?	<p>If interior door is a fire door, check NA.</p> <p>For interior doors (not fire doors), labor force to open a door should be ≤ 5 lbs. Measure the weight of the labor force of the door after the door is unlatched; attach the hook end of the scale to the door handle and pull until the door opens and read the weight of the force.</p>				
42	Is there a clear space 30 inches wide by 48 inches long in the waiting area(s) for a wheelchair or scooter user to park that is not in the path of travel?					
43	Is the path through the medical office free of any objects that stick out into the circulation path that a blind person might not detect with a cane?	<p>If an object protrudes more than 4 inches and is located between 27 inches above the walking surface and below 80 inches, a blind person walking with a cane will not detect it.</p> 				

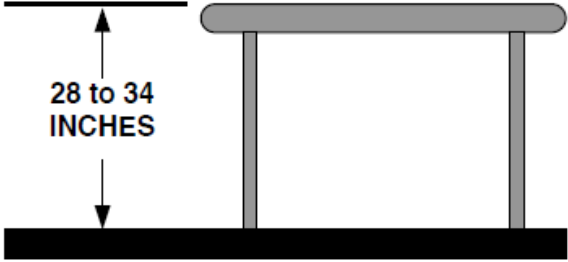
Question #	Criteria (CE = Critical Elements)	Explanation/Guidelines	Yes	No	N/A	Comments
44	If floor mats are used, are the edges of floor mats stiff enough or secured so that they do not roll up?	<p>If floor mats are not in use, check NA.</p> <p>Floor mats that are not secured to the floor can roll up or bunch up under walkers or wheelchair casters and cause a tripping hazard.</p>				
45	Is a section of the sign-in/registration counter no more than 34 inches high and at least 36 inches wide and free of stored items.	 <p>The diagram shows a cross-section of a counter. A horizontal line at the top represents the counter surface. Below it, two vertical lines represent the counter's legs. A double-headed vertical arrow is positioned to the left of the counter, indicating the height from the floor to the top surface. The text '28 to 34 INCHES' is written next to the arrow.</p>				
46	Does the office have a method, other than a lowered counter, by which people can sign in/register? (If yes, please note this method in comments.)	A medical office may use reasonable alternative methods to meet this need such as a clip board.				

Question #	Criteria (CE = Critical Elements)	Explanation/Guidelines	Yes	No	N/A	Comments
------------	-----------------------------------	------------------------	-----	----	-----	----------

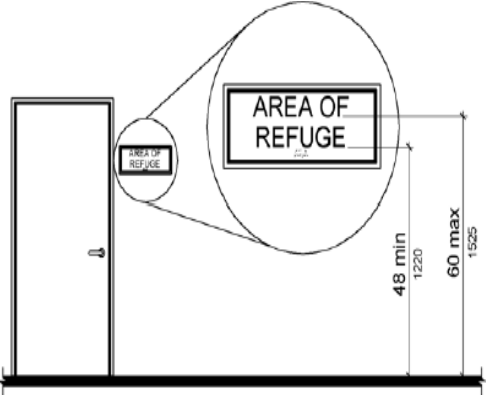
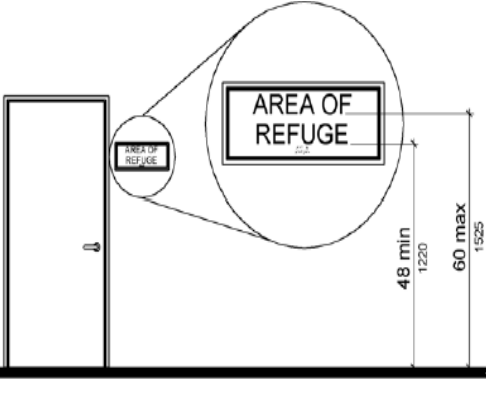
47	Do signs identifying permanent rooms and spaces include raised letters and Braille?					
48	Are the raised letters and Braille signs mounted between 48 inches and 60 inches from the floor?	 <p data-bbox="667 1214 1205 1339">Raised letters and Braille signs are either on the latch side of doors or on the face of doors and are mounted between 48 inches and 60 inches from the floor.</p>				

Question #	Criteria (CE = Critical Elements)	Explanation/Guidelines	Yes	No	N/A	Comments
------------	-----------------------------------	------------------------	-----	----	-----	----------

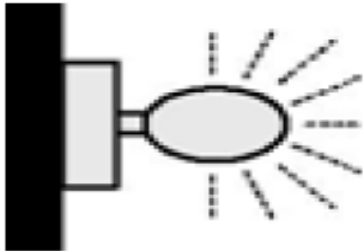
49	<p>If the building has a fire alarm system, are visual signals provided in each public space, including toilet rooms and each room where patients are seen?</p>	<p>If the building does not have a fire alarm system, check NA.</p> 				
----	---	--	--	--	--	--

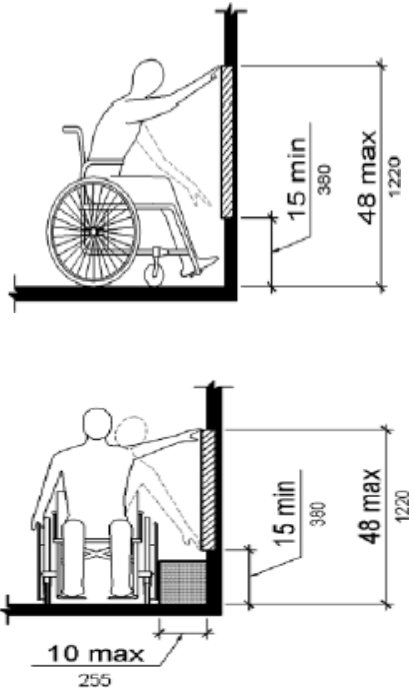
50	<p>Are all patient-operated controls (call buttons, self-service literature, brochures, hand sanitizers, etc.) mounted or presented between 15 inches and 48 inches from the floor?</p>					
----	---	---	--	--	--	--

Question #	Criteria (CE = Critical Elements)	Explanation/Guidelines	Yes	No	N/A	Comments
51	Are all patient operated controls (e.g., call buttons, hand sanitizers) operable with one hand without grasping, pinching, or twisting to operate?	For example, a pump hand sanitizer that must be operated using two hands is inaccessible.				
ELEVATORS						
52	Is there an elevator?					
53 (CE)	If needed, is the elevator available for public/patient use during business hours?	Self explanatory.				

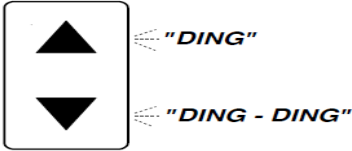
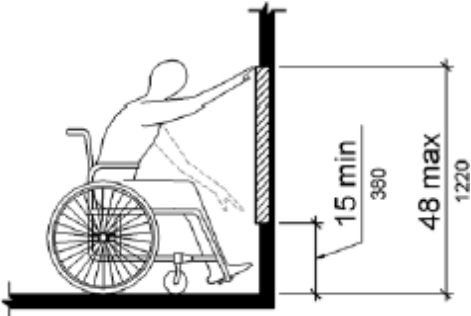
Question #	Criteria (CE = Critical Elements)	Explanation/Guidelines	Yes	No	N/A	Comments
54 (CE)	Is the elevator equipped with both visible and audible door opening/closing and floor indicators?	<p>A visible and audible signal is required at each elevator entrance to indicate which car is answering a call. An audible signal would be a "ding" or a verbal announcement.</p> 				
55 (CE)	Is there a raised letter and Braille sign on each side of each elevator jamb?	<p>These signs allow everyone to know which floor they are on before entering or exiting the elevator.</p>				
56 (CE)	Are the hall call buttons for the elevator no higher than 48 inches from the floor?					

Question #	Criteria (CE = Critical Elements)	Explanation/Guidelines	Yes	No	N/A	Comments
------------	-----------------------------------	------------------------	-----	----	-----	----------

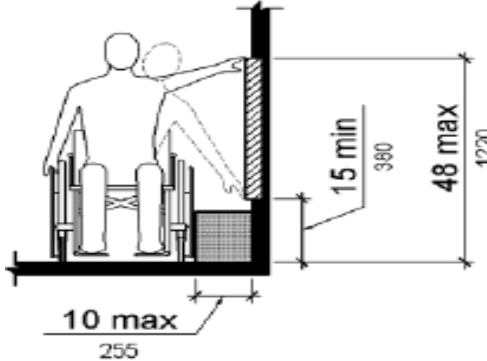
		 <p>The diagram illustrates a person in a wheelchair interacting with a control panel. The wheelchair's width is labeled as 10 max (255). The reach height from the wheelchair seat to the control panel is labeled as 15 min (380). The total height of the control panel is labeled as 48 max (1220).</p>				
--	--	---	--	--	--	--

Question #	Criteria (CE = Critical Elements)	Explanation/Guidelines	Yes	No	N/A	Comments
------------	--------------------------------------	------------------------	-----	----	-----	----------

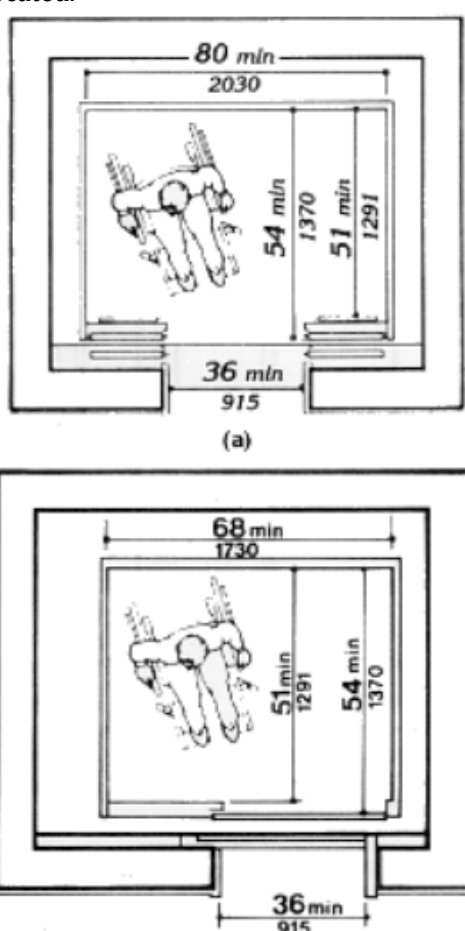
57 (CE)	Is the elevator car large enough for a wheelchair or scooter user to enter, turn to reach the controls, and exit?	<p>The doorway should be at least 36 inches wide and the floor area should be at least 51 inches long and 80 inches wide or 54 inches long and 68 inches wide, depending on where the door is located.</p>  <p>Diagram (a) shows a wheelchair with a 36 min doorway, 54 min length, and 80 min width. The overall car width is 2030 and the doorway width is 915.</p> <p>Diagram (b) shows a wheelchair with a 36 min doorway, 51 min length, and 68 min width. The overall car width is 1730 and the doorway width is 915.</p>				
------------	---	--	--	--	--	--

Question #	Criteria (CE = Critical Elements)	Explanation/Guidelines	Yes	No	N/A	Comments
58 (CE)	Do the buttons on the control panel inside the elevator have Braille and raised characters/symbols near the buttons?	Self explanatory.				
59	Is there an emergency communication system in the elevator?	Self explanatory.				
60	Is the elevator emergency communication system usable without requiring voice communication?	It is essential that emergency communication not be dependent on voice communications alone because the safety of people with hearing or speech impairments could be jeopardized. Visible signal requirement could be satisfied with something as simple as a button that lights when the message is answered, indicating that help is on the way.				

Question #	Criteria (CE = Critical Elements)	Explanation/Guidelines	Yes	No	N/A	Comments
------------	-----------------------------------	------------------------	-----	----	-----	----------

61	Do raised letters and Braille identify the emergency intercom in the elevator?	Self explanatory.				
----	--	-------------------	--	--	--	--

TOILET ROOMS (INCLUDING THOSE USED FOR SPECIMEN COLLECTION)

ALL TOILET ROOMS:

62	Is there an accessible toilet room?	Self explanatory.				
----	-------------------------------------	-------------------	--	--	--	--

63	If there is an inaccessible toilet room, is there directional signage to an accessible toilet room?	Mark NA if there are no inaccessible toilet rooms. Self explanatory.				
----	---	---	--	--	--	--

64	Does the interior door to the restroom require less than 5 pounds of pressure to open?	If restroom door is a fire door, check NA. For interior doors (not fire doors), labor force to open a door should be ≤ 5 lbs. Measure the				
----	--	--	--	--	--	--

Question #	Criteria (CE = Critical Elements)	Explanation/Guidelines	Yes	No	N/A	Comments
------------	-----------------------------------	------------------------	-----	----	-----	----------

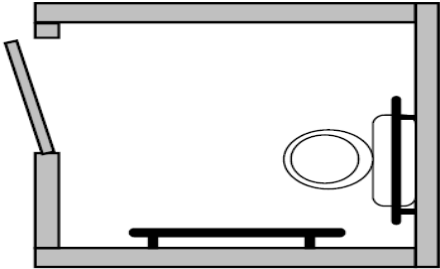
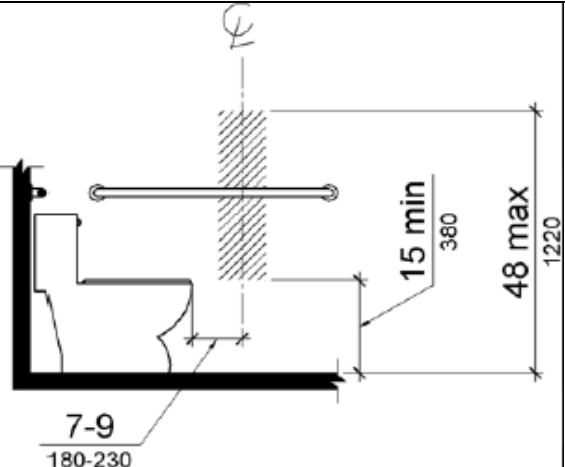
		weight of the labor force of the door after the door is unlatched; attach the hook end of the scale to the door handle and pull until the door opens and read the weight of the force.				
65 (CE)	<p>For all toilet rooms with and without stalls:</p> <p>Are grab bars provided, one on the wall behind the toilet and one on the wall next to the toilet?</p>	<p>Grab bars should be installed in a horizontal position between 33 and 36 inches above the floor measured to the top of the gripping surface.</p> 				
66	Are all objects mounted at least 12 inches above and 1½ inches below the grab bars?	This includes seat cover dispensers, toilet paper dispensers, sanitizers, trash containers, etc.				
67 (CE)	Is the toilet paper dispenser mounted below the side grab bar with the centerline of the toilet paper dispenser between 7 inches and 9 inches in front of the toilet, and at least 15 inches high?					

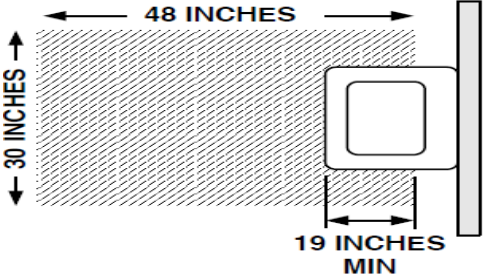
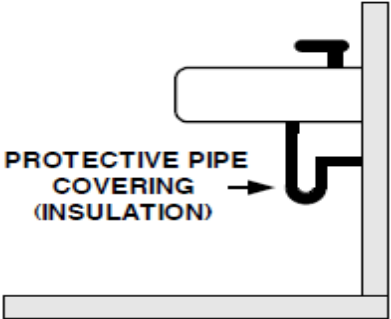
Question #	Criteria (CE = Critical Elements)	Explanation/Guidelines	Yes	No	N/A	Comments
68 (CE)	Is there a space that is at least 30 inches wide and 48 inches deep to allow wheelchair users to park in front of the sink?	<p>This space must extend at least 17 inches under the sink from the front edge, although it can extend up to 19 inches underneath.</p> 				
69	Is the space in front of the sink free of trash cans and other movable items?	Self explanatory.				
70	Are the pipes and water supply lines under the sink wrapped with a protective cover?					
71 (CE)	Are faucet handles operable with one hand and without grasping, pinching, or twisting? (Check Yes if faucets are automatic.)	A knob handle would not be accessible.				

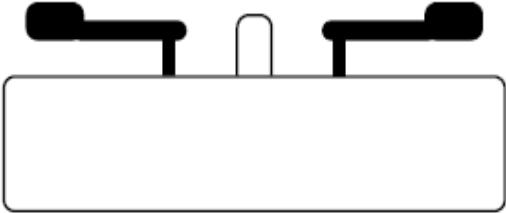
Question #	Criteria (CE = Critical Elements)	Explanation/Guidelines	Yes	No	N/A	Comments
		<p style="text-align: center;">LEVER HANDLES</p> 				
72	Are all dispensers mounted no higher than 40 inches from the floor?	Included are soap dispensers, paper towel dispensers, seat cover dispensers, hand dryers, etc.				
73	Are all dispensers (soap, paper towel, etc.) operable with one hand and without grasping, pinching, or twisting?	Self explanatory.				
74	If there is a pass-through door for specimen collection, is there a 30 inches by 48 inches space for a wheelchair or scooter user to park in front of it?	If there is no such door, check NA.				

Question #	Criteria (CE = Critical Elements)	Explanation/Guidelines	Yes	No	N/A	Comments
------------	-----------------------------------	------------------------	-----	----	-----	----------

TOILET ROOM WITHOUT STALLS

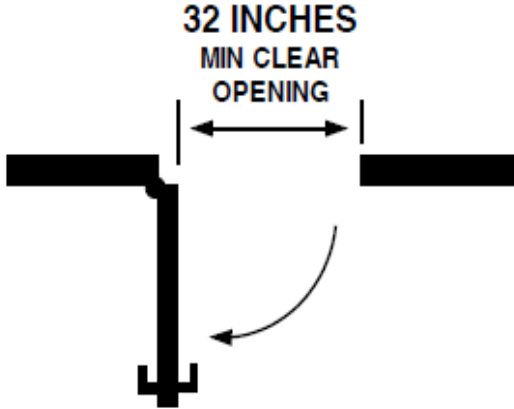
75 (CE)	<p><i>Toilet room without stalls:</i></p> <p>Do toilet room doorways have a minimum clear opening of 32 inches with the door open at 90 degrees, measured between the face of the door and the opposite stop?</p>	<p>If there is no toilet room without stalls, check NA.</p>  <p>The diagram illustrates a door opening at a 90-degree angle. A horizontal double-headed arrow indicates the clear opening between the door's face and the opposite stop, labeled '32 INCHES MIN CLEAR OPENING'. A curved arrow shows the door's path from a closed position to the 90-degree open position.</p>				
76	<p>Is the space inside the toilet room without stalls clear, without trash cans, shelves, equipment, chairs, and other movable objects?</p>	<p>Self explanatory.</p>				

Question #	Criteria (CE = Critical Elements)	Explanation/Guidelines	Yes	No	N/A	Comments
------------	-----------------------------------	------------------------	-----	----	-----	----------

TOILET ROOM WITH STALLS

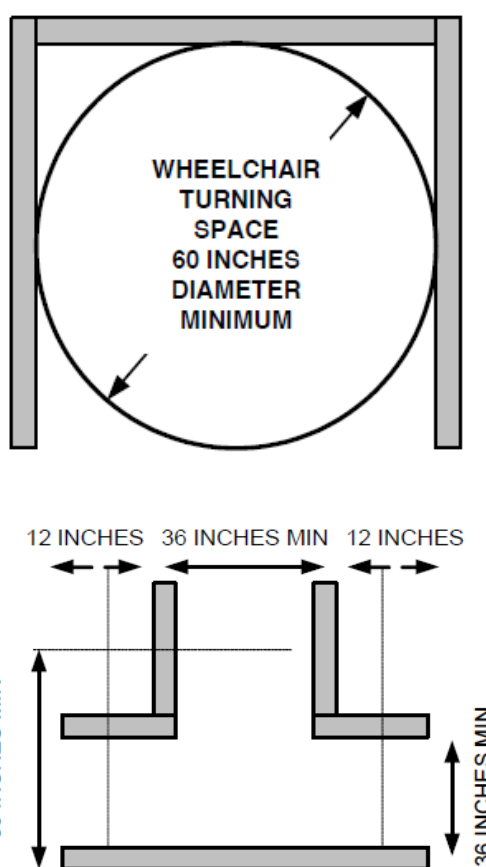
<p>77 (CE)</p>	<p><i>Toilet Room with stalls:</i></p> <p>Is there a 60-inch diameter turning circle or a 60 inch x 60 inch "T"-shaped space inside the toilet room with stalls to allow a turn around for wheelchair and scooter users?</p>	<p>If there is no toilet room with stalls, check NA.</p>  <p>The diagram consists of two parts. The top part shows a square frame with a circle inside. The circle is labeled 'WHEELCHAIR TURNING SPACE 60 INCHES DIAMETER MINIMUM'. The bottom part shows a T-shaped space. The horizontal bar at the bottom is labeled '36 INCHES MIN'. The vertical bars are labeled '12 INCHES' on each side. The total width of the T-shape is labeled '36 INCHES MIN'. The height of the vertical bars is labeled '60 INCHES MIN'.</p>				
--------------------	---	---	--	--	--	--

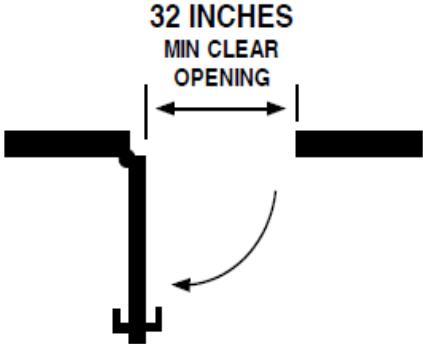
Question #	Criteria (CE = Critical Elements)	Explanation/Guidelines	Yes	No	N/A	Comments
78	Is the space inside the accessible stall clear, without trash cans, shelves, equipment, chairs, and other movable objects?	Self explanatory.				
79	Can the hardware on the stall door be operated without grasping, pinching, or twisting of the wrist?	Handles, pulls, latches, locks, and other operating devices on accessible doors shall have a shape that is easy to grasp with one hand and does not require tight grasping, tight pinching, or twisting of the wrist to operate.				
EXAM/TREATMENT ROOMS/MEDICAL EQUIPMENT						
80 (CE)	Do exam room doorways have a minimum clear opening of 32 inches with the door open at 90 degrees, measured between the face of the door and the opposite stop?					

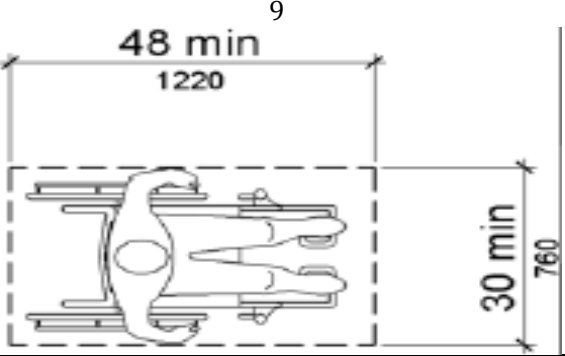
Question #	Criteria (CE = Critical Elements)	Explanation/Guidelines	Yes	No	N/A	Comments
81 (ME)	Is there a height adjustable exam table that lowers to between 17 inches and 19 inches from the floor to the top of the cushion?	Self explanatory				
82 (ME)	Is there space next to the height adjustable exam table for a wheelchair or scooter user to approach, park, and transfer or be assisted to transfer onto the table?	 <p>The diagram illustrates a wheelchair positioned next to a table. A dashed rectangle represents the wheelchair's footprint, with a width of 48 inches and a length of 1220. A vertical dimension of 30 inches indicates the clearance between the wheelchair and the table. A total length dimension of 760 is also shown.</p>				
83	Does the exam table provide elements to assist during a transfer (such as rails) and support a person while on the table? (If yes, please list in comments.)	Items that could help support a patient while on the table would be armrests, side rails, padded straps, cushions, wedges, etc.				

Question #	Criteria (CE = Critical Elements)	Explanation/Guidelines	Yes	No	N/A	Comments
------------	-----------------------------------	------------------------	-----	----	-----	----------

84	Is a lift available to assist staff with transfers (portable, overhead, or ceiling mounted)?	Self explanatory.				
----	--	-------------------	--	--	--	--

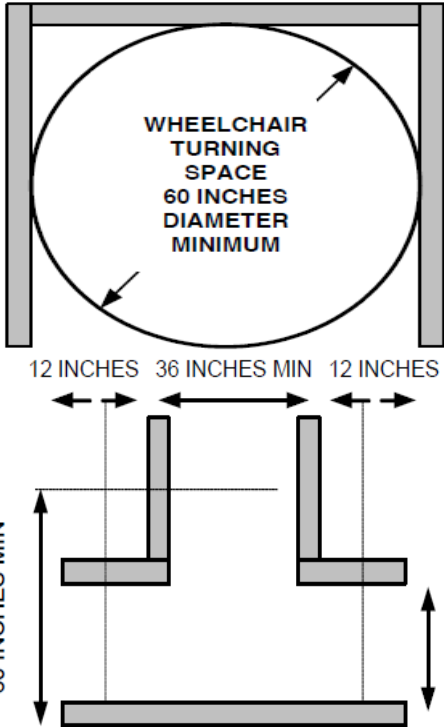
85 (CE)	Is there a 60 inch diameter turning circle or a 60 inch x 60 inch "T"-shaped space so that a wheelchair or scooter user can make a 180° turn?	 <p style="text-align: center;">WHEELCHAIR TURNING SPACE 60 INCHES DIAMETER MINIMUM</p> <p style="text-align: center;">12 INCHES 36 INCHES MIN 12 INCHES</p> <p style="text-align: center;">60 INCHES MIN 36 INCHES MIN</p>				
---------	---	--	--	--	--	--

Question #	Criteria (CE = Critical Elements)	Explanation/Guidelines	Yes	No	N/A	Comments
86 (ME)	Is a weight scale available within the medical office with a platform to accommodate a wheelchair or scooter and the patient?	Accessible scales are usable by all people including: wheelchair users, people with activity limitations, and larger people who may exceed a standard weight scale limit. This includes people with conditions that interfere with mobility, walking, climbing, using steps (joint pain, short stature, pregnancy, fatigue, respiratory and cardiac conditions, post surgical conditions, orthopedic injuries); and/or who use mobility devices (e.g. canes, crutches, walkers).				

References

2010 ADA Standards for Accessible Design

U.S Department of Justice

http://www.ada.gov/2010ADASTandards_index.htm

The revised regulations for Titles II and III of the Americans with Disabilities Act of 1990 (ADA) were published in the Federal Register on September 15, 2010. They provide the scoping and technical requirements for new construction and alterations resulting from the adoption of revised 2010 Standards in the final rules for Title II (28 CFR part 35) and Title III (28 CFR part 36). The 2010 ADA Standards go into effect March 15, 2012, but can be used now instead of the 1991 standards. The FSR Attachment C draws upon access requirements found in both the 1991 Americans with Disabilities Act Accessibility Guidelines and the 2010 ADA Standards. Some diagrams that appear in the FSR Attachment C are reproduced from these sources.

Two questions in the FSR Attachment C were drawn from Title 24, Part 2 of the California Building Standards Code. These are

1133B.4.4 – Striping for the visually impaired (Rev.1-1-2009), and 1115B-1 – Bathing and Toilet Facilities, placement of toilet paper dispensers. These standards can be found in:

2009 California Building Standards Code with California Errata and Amendments

State of California

Department of General Services

Division of the State Architect

Updated April 27, 2010

http://www.documents.dgs.ca.gov/dsa/pubs/access_manual_rev_04-27-10.pdf

Some diagrams are reprinted with permission from the Kentucky Department of Vocational Rehabilitation. These illustrations can also be found in:

“Health Care Usability Profile V3”

Copyright 2008

Oregon Health & Science University RRTC: Health & Wellness

Authors: Drum, C.E., Davis, C.E., Berardinelli, M., Cline, A., Laing, R., Horner-Johnson, W., & Krahn, G.

Oregon Institute on Disability and Development

Portland, OR 97239

rrtc@ohsu.edu

healthwellness.org